

## Functional description

With the automatic sash controller SC500, SCHNEIDER offers a product for additional safety and energy savings in the laboratory environment.

A passive infrared movement detector (PIR) constantly monitors the work area in front of the fume hood. If no operating personnel are directly in front of the fume hood, the fully automatic sash closing process is started following an adjustable closing delay time (10 seconds to 30 minutes).

The containment of a fume hood is at its highest when the sash is closed. Significant energy savings can be achieved if the exhaust air volume is simultaneously reduced by use of the SCHNEIDER FC500 fume hood controller.

An infrared light barrier mounted on the handle bar stops the sash automatically if an obstruction is detected during the closing process.

The motor-driven drive unit consists of the cable deflection pulleys and the drive roller as well as a maintenance-free servo motor and a safe magnetic clutch.

## Diversity factor and energy efficiency

Whenever possible, the automatic sash controller moves the fume hood sash into the closed position.

In the case of air controlled fume hoods, a diversity factor of approximately 50-60% can be calculated when planning the ventilation technology, whereby the investment and operating costs of the entire plant can be considerably reduced. Thus energy savings of 50% can be achieved.

## Ease of use and safety

A foot switch for the UP function increases ease of use and can optionally be connected.

The sash can be opened or closed manually at any time. Manual intervention in the automatic closing process is also safely possible at any time. As the sash is usually closed, the safety of the laboratory personnel is considerably improved.

The lowering delay time of the sash can be extended by pressing the optionally connectable time extension button during setup.

## Control panel

Via the control panel the sash can be opened or closed automatically using the buttons UP, DOWN, STOP.



## Performance features

- Microprocessor controlled automatic closing system for fume hood sashes
- Integrated power supply 230V AC or 115V AC
- All system data are saved mains voltage failure-safe in the EEPROM
- Programming of all system values via service module SVM100 or laptop software PC2500
- Automatic adjustment of the sash position via buttons (UP, DOWN, STOP), foot switch or manually
- Motor-driven opening or closing of the sash directly via pushing the window UP or DOWN (touch control mode)
- 10 freely selectable speeds with soft stop
- Motor current monitoring with automatic shutoff (manual intervention)
- Monitoring of closing time
- Teach-in mode for easy commissioning of different fume hood types
- Start of the closing process via passive infrared movement detector
- Monitored closing process via infrared light barrier and automatic shutoff on obstruction recognition
- Reduced cabling effort through the use of 2-wire light barrier using both sash cables is possible
- Lowering delay time adjustable from 10 sec to 30 min
- Optionally connectable time extension button for extending the lowering delay time (fume hood setup)
- Automatic, electronic adjustment of the drive when free movement of the sash is changed
- Programming of the system via the FAZ on the fume hood (RS 485 – together with the FC-500 controller)
- Improvement in safety and reduction of the air requirement by the predominant operating state sash closed
- Suitable for all fume hood constructions, independent of the opening or closing method

Operation

**Operation**

Independent of the automatic sash closing the sash can be operated manually at any time.

**Manual operation**  
(Option: touch control mode = off)

If the sash is in a stationary position, it can be manually pushed up or down using the handle bar on the sash. The drive unit and the sash are decoupled when the sash is in a stationary position.

**Motor-driven opening or closing of the sash**  
(Option: touch control mode = on)

If the sash is manually pushed in the direction UP or in the direction DOWN, the internal electronics recognize the direction and open or close the sash via the motor (see points 3 and 4).

**Motor-driven opening of the sash via the UP button**

Briefly press the UP button or the foot switch. The sash is opened and automatically stops in the position TOP or at the stopping point Centre (if 3 stopping points have been programmed). Briefly pressing the buttons UP, DOWN or STOP immediately halts the movement of the sash. The upwards movement is monitored for obstructions with the emitter/receiver light barrier (see Recognition of obstructions).

**Motor-driven closing of the sash (via the DOWN button)**

Briefly press the DOWN button. The sash is closed and automatically stops in the position BOTTOM (limit switch BOTTOM). Briefly pressing the UP, DOWN or STOP button immediately halts the movement of the sash. The downwards movement is monitored for obstructions by the emitter/receiver light barrier (see Recognition of obstructions).

**Automatic closing**

The lowering delay time is freely programmable from 10 sec. to 30 min. If no activity on the fume hood is registered by the time the lowering delay time has expired, the sash automatically closes and stops in the BOTTOM position. As soon as a person is detected in the working area of the fume hood by the passive infrared sensor (PIR), the sash movement immediately stops (programmable). The downwards movement is monitored for obstacles by the emitter/receiver light barrier (see Recognition of obstructions).

**Recognition of obstructions**

If the sash is in the process of moving downwards, the area directly below the handle bar is monitored with an emitter/receiver light barrier. The sash is automatically halted if this signal is interrupted by reaching into the working area or by objects that reach out from the interior.

If a recognized obstruction has led to the sash closing process being stopped, automatic closing is deactivated. Automatic closing is activated again by pressing the UP or DOWN button or by manually pushing the sash at least 3 cm, that is, normal operation is again ensured. The deactivation of automatic closing after recognition of an obstruction takes place for safety reasons. It is also possible to program other reactivation criteria.

**Time extension button**

By pressing the TIME EXTENSION button the lowering delay time of the sash is extended by a programmable time period (1...30 minutes). By repeatedly pressing this button the time period is summed up internally (max. 4 additions).

If, for example, the fume hood must be equipped with new devices or if the sash should not be closed for a prolonged period, it makes sense to use this function. A maximum extension of the lowering delay time of 4 x 30 minutes = 2 hours may be achieved.

**Schematic diagram:**  
**Automatic sash controller SC500**

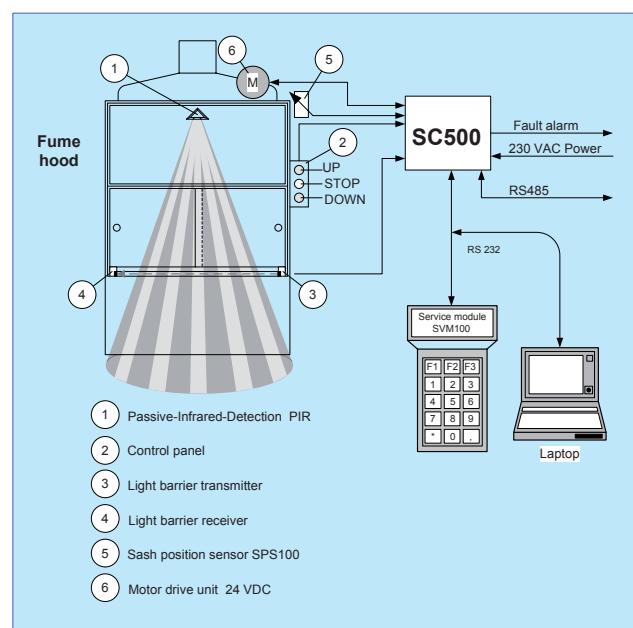

**Scope of delivery**  
**Automatic sash controller SC500**

The automatic sash controller SC500 (full construction) includes the following components:

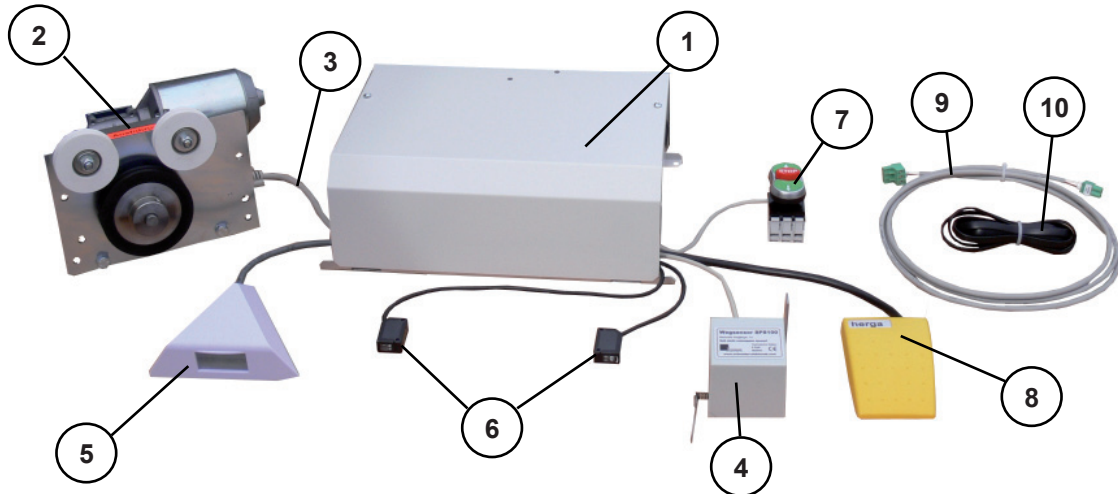

Pos.	Units	Object
1	1	Control electronics in casing with power supply (230V AC or 115V AC)
2	1	Motor drive unit with clutch
3	1	3m connection cable motor drive unit
4	1	Sash position sensor SPS100
5	1	Passive infrared sensor
6	1	Infrared light barrier transmitter/receiver for registering objects during the closing process
7	1	<b>Additional accessory:</b> Panel UP/STOP/DOWN (please order separately. Cable not included)
8	1	<b>Additional accessory:</b> Foot switch for opening the sash (please order separately)
9	1	<b>Additional accessory:</b> Interconnection to FC500 for SPS100 (sash position sensor) signal
10	1	<b>Additional accessory:</b> Interconnection to FC500 for parameterise the SC500 via FC500 functional display socket

**NOTE**

The following mounting methods are permissible for the SC500 automatic sash controller:

**Control electronics**

- Mounted flat on the roof of the fume hood (horizontal mounting) always with the lid facing upwards.
- Screwed to the fume hood wall (vertical mounting).



**Motor drive unit**

- Mounted flat on the fume hood roof (horizontal mounting).
- Screwed to the fume hood wall (vertical mounting). Angle brackets are optionally included.

Order code: Automatic sash controller

**Order code: Automatic sash controller**

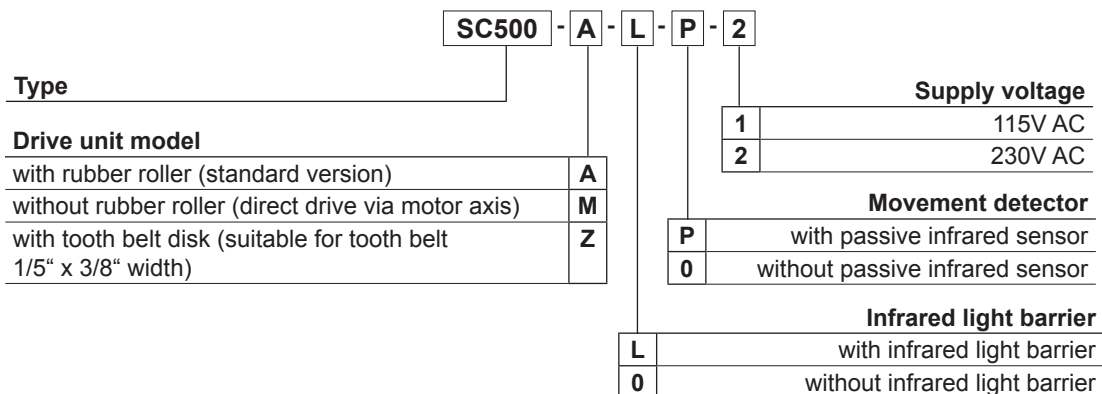

**Ordering example: Automatic Sash Controller SC500**

Automatic sash controller with sash position sensor SPS100, drive unit with rubber roller with infrared light barrier for recognition of obstructions during the lowering process and passive infrared movement detector, supply voltage 230V AC

**Make: SCHNEIDER      Type: SC500-A-L-P-2**

**Order code: Control panel**



**Ordering example: Control panel**

Control panel with buttons UP/DOWN/STOP

**Make: SCHNEIDER      Type: PAN100**

**Order code: Foot switch**



**Ordering example: Foot switch**

Foot switch for UP function

**Make: SCHNEIDER      Type: FS100**

**Technical data**

■ General	
Nominal voltage	230V AC/50/60Hz/+-15% 115V AC/50/60Hz/+-15%
(see terminal diagram for correct Jumper position of JP1 and JP2)	
Fuse F1 (230V AC)	500mA/250V delay fuse
Fuse F1 (115V AC)	1A/115V delay fuse
Fuse F2	3.15A/250V delay fuse
Max. power input	80 VA
Operating temperature	+5 °C to +40 °C
Humidity	max. 80 % relative, non-condensing

■ Controller case	
Protection type	IP 20
Material	sheet steel
Colour	white, app. RAL 9002
Dimensions (LxWxH)	(290 x 208 x 100) mm
Weight	approx. 3.2 kg
Terminals	screw terminal 1.5 mm <sup>2</sup>

■ Drive unit	
Weight	approx. 4.6 kg
Dimensions (WxHxD)	(200 x 200 x 180) mm
Torque motor	approx. 3 Nm
Torque magnetic clutch	approx. 7 Nm
Up / Down time for 50 cm sash opening	typ. 3,5 ... 9 s (depending on setting values)
Up / Down time for 90 cm sash opening	typ. 6 ... 15 s (depending on setting values)

### Terminal diagram: Automatic Sash Controller SC500

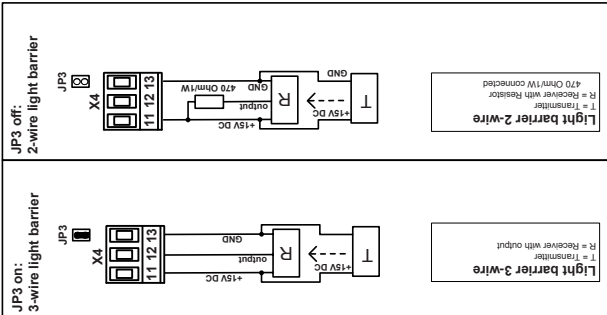
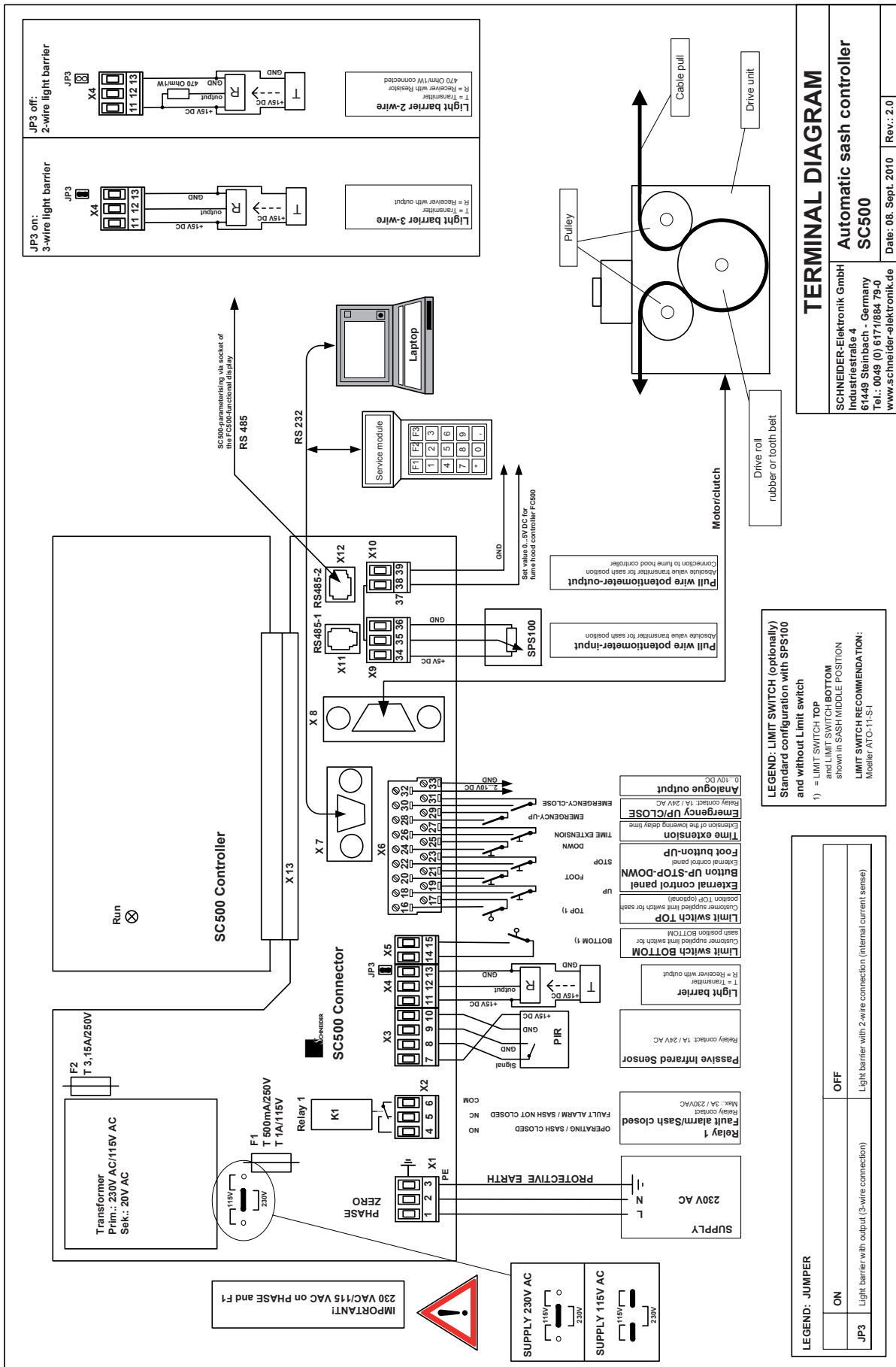

<b>TERMINAL DIAGRAM</b>	
<b>SCHNEIDER-Elektronik GmbH</b> <b>Automatic sash controller</b> <b>SC500</b>	
SCHNEIDER-Elektronik GmbH Industriestraße 4 Tel.: 0049 (0) 617 1884 79-0 www.schneider-elektronik.de	
Date: 08. Sept. 2010	Rev.: 2.0

**LEGEND: LIMIT SWITCH (optionally)**  
Standard configuration with SPS100  
and without Limit switch  
1) = LIMIT SWITCH TOP  
and LIMIT SWITCH BOTTOM  
shown in SASH MIDDLE POSITION  
**LIMIT SWITCH RECOMMENDATION:**  
Mocell-ATO-11-S-1

<b>LEGEND: JUMPER</b>	
ON	OFF
JP3	Light barrier with output (3-wire connection)
	Light barrier with 2-wire connection (internal current sense)

**Case SC500: Top view**

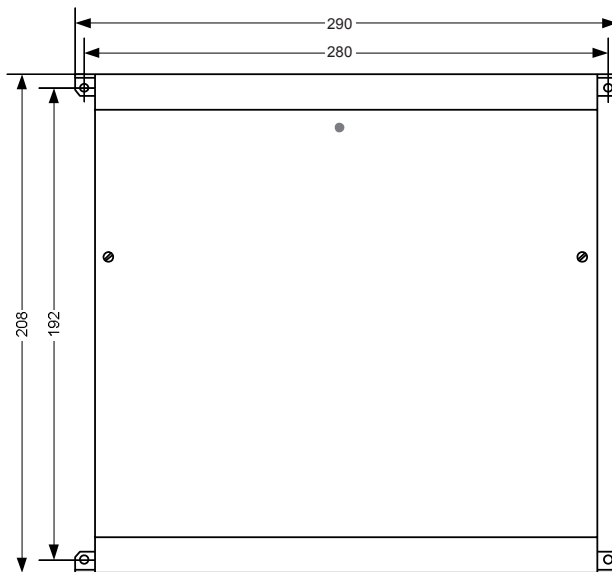

**Case SC500: Side view**

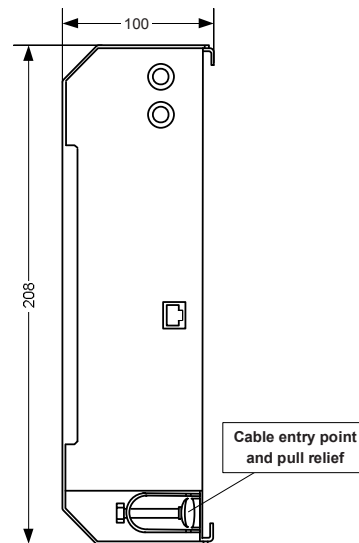

**Drive unit SC500: Front view**

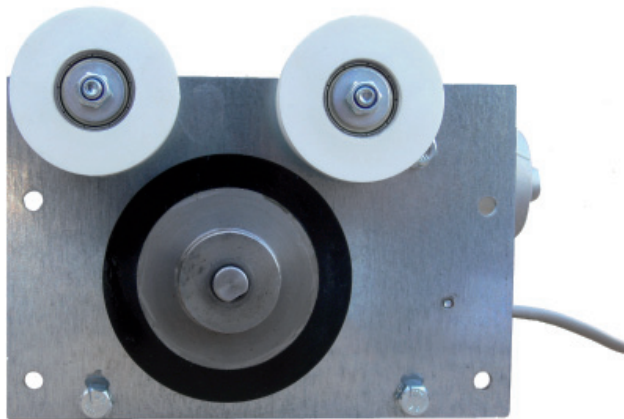

### Tender specification SC500

Automatic sash closing system, motor driven. The closing process is automatically started by a passive infrared movement detector (PIR) as soon as no operating personnel is immediately in front of the fume hood.

Motor operated automatic sash closing system with magnetic clutch. Monitoring of the sash closing time and malfunction notification when the closing time is exceeded. Closing delay freely adjustable from 10 sec to 30 min. Sash position electrically adjustable via control buttons (UP, DOWN, STOP) or by manual intervention. Optionally connectable time extension button for extending the lowering delay time (fume hood setup). An object (e.g. measuring probe, cable, etc.) recognized by the infrared light barrier that monitors the closing process will cause an automatic STOP. Motor

overcurrent monitoring with automatic shutoff (manual intervention). Automatic, electronic adjustment of the drive when free movement of the sash is changed. Suitable for all fume hood constructions, independent of the closing or opening method.

Free programming of all system data, such as setpoints, via the service module or optionally PC, as well as readout of all actual values and mains voltage failure-safe storage of all data. Easy commissioning via TEACH IN software. Easy integration into a building management system (BMS).

**SCHNEIDER Elektronik GmbH**  
Industriestraße 4  
61449 Steinbach • Germany

Phone: +49 (0) 6171 / 88 479 - 0  
Fax: +49 (0) 6171 / 88 479 - 99  
e-mail: [info@schneider-elektronik.de](mailto:info@schneider-elektronik.de)